



**Timber Care & Preservation**  
Furnitubes offer all our customers the following advice when installing our range of exterior-use timber seating. Normal weather conditions can cause shrinkage and cracking in all timber products, due to their natural reaction to the elements. Most Furnitubes' timber products are supplied untreated, enabling application of the most appropriate preservative for the particular installation site. Please see appendices or contact your local Wood Preservation Specialist for further details and recommendations.

# EASTGATE

## range

The Eastgate's intricate and regal styling complements Victorian and Edwardian architecture, making it ideal for areas where conservation and heritage are important.

The Eastgate seat is also available with a central arm that is often beneficial to the elderly user or to those with disabilities.



▲ EASTGATE SEAT  
with painted standards  
installed in Guild Street Bus Station, Aberdeen



▲ EASTGATE SEAT  
with painted standards, central arm-rest & date motif  
installed at Chelmsford Bowls Club, Essex

The Eastgate may be supplied with the year of production (as pictured left) or with simple crests and logos cast into the end standards.

Also, seats for presentation, commemoration or memorial use are available with an engraved bronze plaque attached to the backrests of the seats.



▲ OCTAGONAL EASTGATE SEAT  
(special commission)



### RECYCLED COMPOSITE SLATS

The Eastgate seat is also available with recycled composite slats, made from 100% recycled material, consisting of 50% sawdust & 50% HDPE. See page 165 for more details.



Furnitubes cast iron is 100% recyclable



Furnitubes timber is 100% biodegradable



Legally sourced certified timbers available on request



Seat height & arm rests can be an aid when alighting



Furnitubes recycled slats are made from 100% recycled material



# EASTGATE

range



## EASTGATE BENCH

The Eastgate seat and bench have been designed to permanently enhance the elegance of both public and private developments. They have been used by Developers and Local Authorities throughout the UK in diverse environments such as parks, pedestrianisation schemes, hospitals and schools.



**EASTGATE BENCH** ▲▲  
supplied to Lower Paddock Road,  
South Oxney, South Watford

### TECHNICAL

#### Cast Iron Finish

Seat standards are supplied in gloss black finish as standard. Other BS 4800 & RAL series colours are available on special request.

#### Timber Finish

Standard finish is natural planed. Coated timbers and Graffiti Removal System are available on special request. Please refer to the appendices.

#### Fixing

Seat feet are pre-drilled at positions shown in blue to allow for fixing down.

#### Date Motif

Commemorative date of issue motif is available on the Eastgate range & is highlighted in gold.

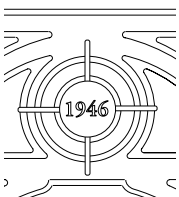

#### Inscriptions

Seats for presentation, commemoration or memorial use are available with an engraved bronze plaque attached to the timber back rail.

Product Codes are in **bold type**. Dimensions are in mm, are approximate and do not form any part of the contract.

We reserve the right to change the design and specification on any item offered and, where possible, notification will be made.

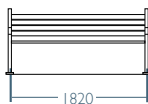
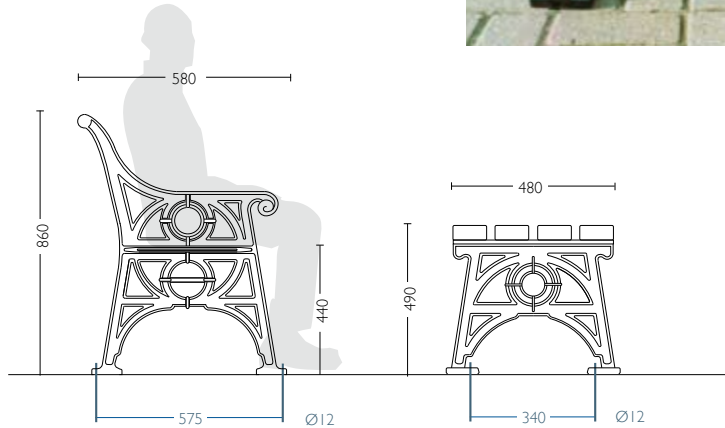

96kg



72kg

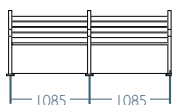

130kg



75kg

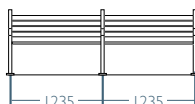

135kg



78kg

#### EASTGATE SEAT

Cast Iron Standards, Iroko Timber Slats

**EA 6**  
1860mm overall length Seat (no Date Motif)

**EA 7C**  
2190mm o/all length Seat with Centre Standard Arm includes Date Motif as standard

**EA 8C**  
2490mm o/all length Seat with Centre Standard Arm includes Date Motif as standard

#### OPTIONS:

- Date Motif
- Engraved Bronze Plaque
- Recycled Composite Slats (see page 165)
- 10mm Block for DDA Compliance

#### EASTGATE BENCH

Cast Iron Standards, Iroko Timber Slats

**EAB 6**  
1800mm overall length Bench (no Date Motif)

**EAB 7**  
2100mm overall length Bench (no Date Motif)

**EAB 8**  
2400mm overall length Bench (no Date Motif)

#### OPTIONS:

- Date Motif
- Engraved Bronze Plaque
- Recycled Plastic Slats (see page 164)

The Eastgate may be supplied with the year of production (as pictured) or with simple crests and logos cast into the arms. Bronze plaques can be attached to the backrests of the seats.

All cast iron and timber seats are supplied painted as standard. An extensive range of BS / RAL colours are available and date plaques and logos can also be supplied highlighted with a contrasting or metallic paint.



▲ EASTGATE date motif



Furnitubes cast iron is 100% recyclable



Furnitubes timber is 100% biodegradable



Legally sourced certified timbers available on request



Seat height & arm rests can be an aid when alighting

▼ NEW FOREST Seat supplied to Sacred Heart Primary School, Ruislip, West London



# NEW FOREST *range*

The contemporary form of the New Forest range was engineered to take into account developments in casting technology, economic use of materials and to provide optimum ergonomics.

The ends of the timbers are secured within and protected by the inner profile of the cast end standards. Also, the fixings are not visible from the front which minimises damage to clothing and the risk of vandalism.

The range is available in several lengths and the addition of a central arm assists both abled and disabled people to get in and out of the seat more easily.



▲ NEW FOREST Bench  
supplied to Staines High St, Middlesex



▲ NEW FOREST Seat  
installed at Halliwell Court, Barry Road, Southwark, London

## OPTIONS

Available on request



Other BS/RAL colours  
- black as standard



Engraved bronze plaque



Coated timbers &  
Graffiti Removal Systems



Furnitubes cast iron is 100% recyclable



Furnitubes timber is 100% biodegradable



Legally sourced certified timbers available as special request



Seat height & arm rests can be an aid when alighting

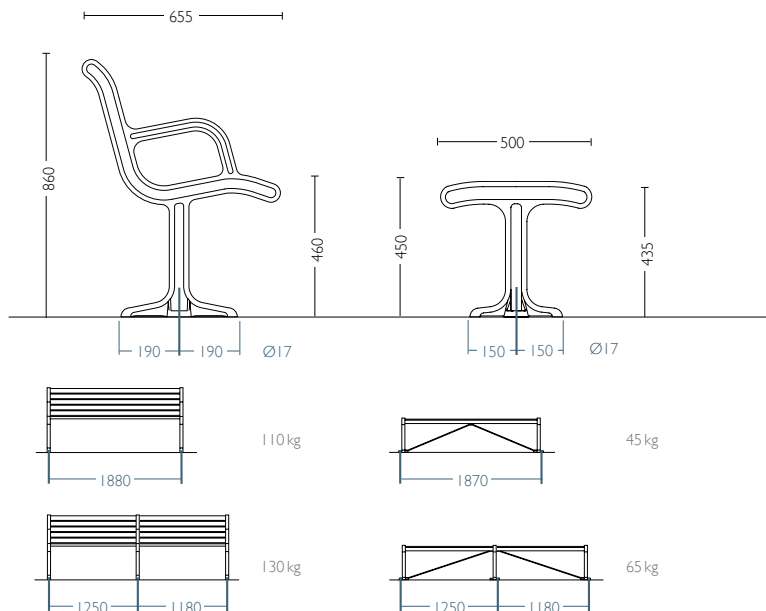

### NEW FOREST SEAT

Cast Iron Standards, Iroko Timber Slats, with Steel Strap Support

**NE 6**  
1840mm overall length Seat

**NE 8C**  
2440mm overall length Seat with Centre Standard & Arm

**OPTIONS:**  
Engraved Bronze Plaque  
Recycled Composite Slats (see page 165)

### NEW FOREST SINGLE BENCH

Cast Iron Standards, Iroko Timber Slats, with Steel Strap Support

**NEB 6**  
1830mm overall length Bench

**NEB 8**  
2440mm overall length Bench With Centre Standard

## TECHNICAL

**Cast Iron Finish**  
Seat standards are supplied in gloss black finish as standard. Other BS 4800 & RAL series colours are available on special request.

**Timber Finish**  
Standard finish is natural planed. Coated timbers and Graffiti Removal System are available on special request. Please refer to the appendices.

**Fixing**  
Seat feet are pre-drilled at positions shown in blue to allow for fixing down.

**Inscriptions**  
Seats for presentation, commemoration or memorial use are available with an engraved bronze plaque attached to the timber back rail.

Product Codes are in **bold type**. Dimensions are in mm, are approximate and do not form any part of the contract.

We reserve the right to change the design and specification on any item offered and, where possible, notification will be made.



## RECYCLED COMPOSITE SLATS

The New Forest seat is also available with recycled composite slats, made from 100% recycled material, consisting of 50% sawdust & 50% HDPE. See page 165 for more details.



# JUBILEE *range*



▲ **JUBILEE STEEL SEAT**  
plastic coated  
as supplied to Turton High School, Bolton



▲ **JUBILEE STEEL & TIMBER SEAT**  
installed at the Broadway, Kidlington, Oxfordshire

The modern Jubilee range is manufactured from steel to withstand today's harsh environments.

The plastic coated, heavy-duty box frame construction is the ideal choice for schools, hospitals, transport interchanges or remote locations where vandalism could be an issue.

The Jubilee bench and seat are supplied plastic coated as standard, but are available in a variety of other finishes. See technical for more information.



Furnitubes steel is 100% recyclable



Furnitubes timber is 100% biodegradable



Legally sourced certified timbers available as special request



Seat height & arm rests can be an aid when alighting



▲ **JUBILEE STEEL BENCH**  
plastic coated  
as supplied to Willenhall EE&T Centre, Coventry

### RECYCLED COMPOSITE SLATS

The Jubilee seat and bench are also available with recycled composite slats, made from 100% recycled material, consisting of 50% sawdust and 50% HDPE. See page 165 for more details.



# JUBILEE range

## MORE OPTIONS

Building on the strength of the Jubilee steel range, timber slatted versions of the seat and bench are now available. Heavy duty legs offer a high degree of resistance to knocks and scratches while the slats provide the natural elegance of hardwood.



▲ JUBILEE STEEL & TIMBER BIN  
(see litter & waste section)

A Jubilee litter bin is also available to complement these designs (see Litter & waste) and the Jubilee could also be produced in stainless steel on special request.

## JUBILEE RANGE



steel bin  
pg 224



timber bin  
pg 234



tree protection  
pg 312



▲ JUBILEE STAINLESS STEEL & TIMBER SEAT  
(special commission)



▲ JUBILEE STEEL & TIMBER BENCH

## TECHNICAL

### Timber Finish

Standard finish is natural planed. Coated timbers and Graffiti Removal System are available on special request. Please refer to the appendices.

### Fixing

Seat feet are pre-drilled at positions shown in blue to allow for fixing down.

### Finishes

The Jubilee Seat and Bench are available in the following finishes:

### Powder Coating

A hard wearing, weatherproof surface. Large range of BS/RAL colours are available.

### Enhanced

#### Powder Coating

Involves a specialist pre-treatment process. Large range of BS/RAL colours are available.

#### Plastic Coating

Hardwearing, high degree of durability and vandal resistance. Available in the following colours:

- ☐ RAL 9016 - White
- ☐ RAL 1021 - Yellow
- ☐ RAL 5015 - Blue
- ☐ RAL 3020 - Red
- ☐ RAL 6005 - Green
- ☐ RAL 8017 - Brown
- ☐ RAL 7001 - Grey
- ☐ RAL 9005 - Black

For further information on paint finishes refer to pages 337-339.

Product Codes are in **bold type**. Dimensions are in mm, are approximate and do not form any part of the contract.

We reserve the right to change the design and specification on any item offered and, where possible, notification will be made.

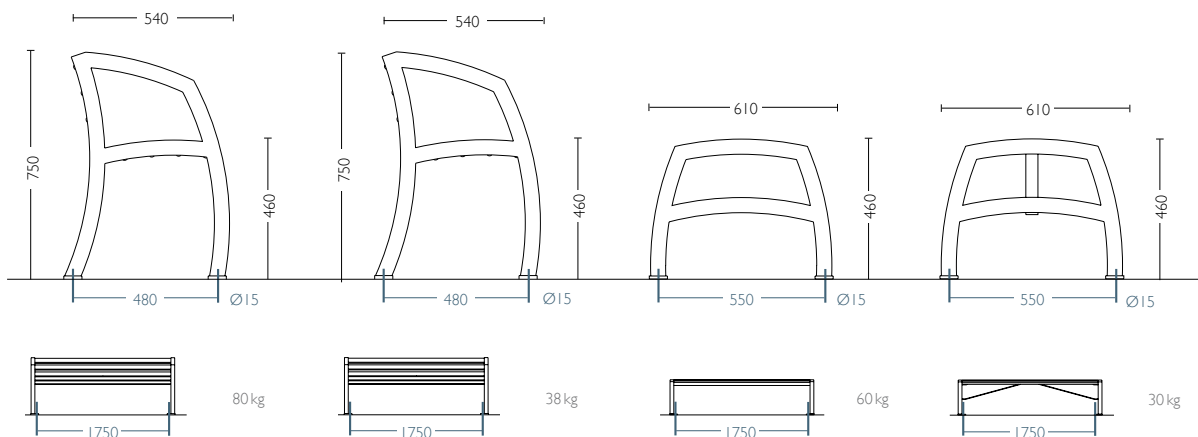

### JUBILEE STEEL SEAT

**JUB6**  
1900mm overall length Seat  
Formed Steel Frame & Slats  
Plastic Coated Finish

**OPTIONS:**  
Enhanced Powder Coated Finish  
Stainless Steel  
Galvanised Steel

### JUBILEE STEEL & TIMBER SEAT

**JUB6 T**  
1900mm overall length Seat  
Formed Steel End Standards  
Plastic Coated Finish  
Iroko Timber Slats, Natural Planed Finish

**OPTIONS:**  
Enhanced Powder Coated Standards  
Powder Coated Standards  
Stainless Steel  
Galvanised Steel Standards  
Recycled Composite Slats (see page 165)

### JUBILEE STEEL BENCH

**JUB6 B**  
1900mm overall length Bench  
Formed Steel Frame & Slats  
Plastic Coated Finish

**OPTIONS:**  
Enhanced Powder Coated Finish  
Stainless Steel  
Galvanised Steel

### JUBILEE STEEL & TIMBER BENCH

**JUB6 BT**  
1900mm overall length Bench  
Formed Steel End Standards & Strap  
Plastic Coated Finish  
Iroko Timber Slats, Natural Planed Finish

**OPTIONS:**  
Enhanced Powder Coated Standards  
Powder Coated Standards  
Stainless Steel  
Galvanised Steel Standards  
Recycled Composite Slats (see page 165)

