

# Bollards.

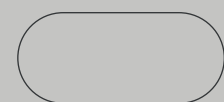

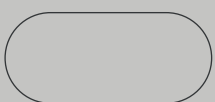

# Bollards.

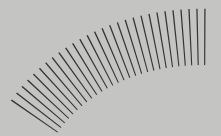
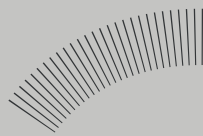
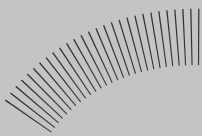
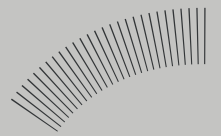
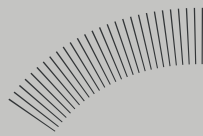
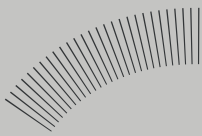
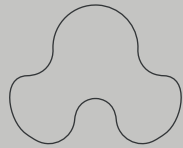
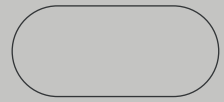
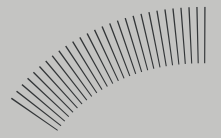
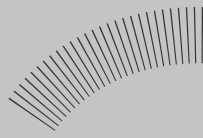
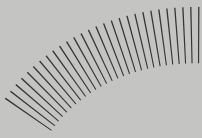
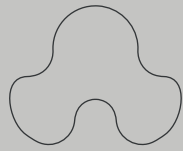
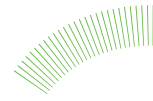

**Bollards have been a prominent symbol on our streets for centuries, love them or hate them they serve to protect buildings and pathways and guide pedestrians the right way.**

## What a load of bollards

Our range come in different shapes, sizes, and materials each having its own aesthetic and function.

Steel and stainless steel posts are most commonly found on pathways and retail developments and cast iron styles are ideal for heritage sites and highways. There are also collapsible / removable bollards that can be folded and stored when not in service, ideal for areas where temporary access is required. Timber bollards naturally weather overtime, making them well suited for countryside environments.

Installing bollards in public spaces are a quick and effective way to enforce unauthorised access to a shops, residential areas or parking spaces. Browse our Bollard range to find the best bollard suited for your scheme. Need help choosing? We offer professional advice to assist your bollard product selection.

## Why choose a Furnitubes bollard?

- **You choose** - Various styles and functional options
- **Sustainable** - many of our bollard ranges are made from recyclable materials
- **Easy to maintain** - hardwearing & high-quality products
- **Quick lead times** - on all stock bollards

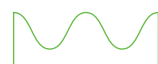

# A material for every location.

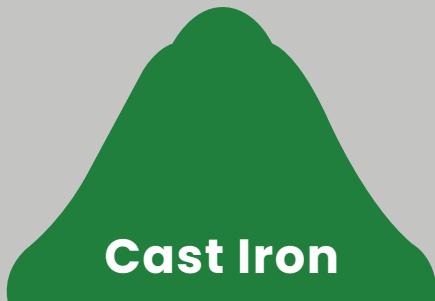

- Supplied in primed finish as standard, for ease of on-site application of top coats
- Removable options; cast in aluminium (excluding Capital)
- Bollards can be painted to a limited selection of **colours**
- Reduce the environmental impact of your scheme, all cast iron bollards are **100% recyclable**



- Our steel bollards are available in a variety of **diameters** and **lengths**
- Grade 304 - suitable for most exterior situations
- Grade 316 - suitable for aggressive environments such as coastal or industrial locations
- Satin polished offered as standard



- Available in Opepe or Oak timber
- Removable options
- Selected ranges are available with grooves or tape
- Our timber bollards are naturally **reusable** and **recyclable**

# Cast Iron Bollards.

## Timeless & Traditional

Cast iron bollards have been used as boundary markers in our towns and cities for many centuries, and in more recent times as an effective means of segregating pedestrians and vehicles on our increasingly busy streets.

Cast iron bollards are manufactured using traditional founding techniques, giving a distinctive surface finish derived from the sand face of the moulds, and is a process that is particularly suited to creating intricate three dimensional detailing.

## CAST IRON BOLLARDS

**Cannon**



**Doric**



**Bell Bollard 100**



**Bell Bollard 120**

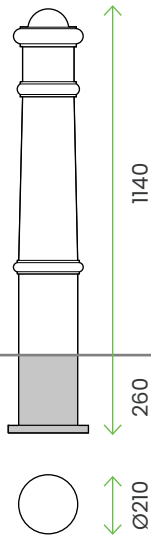

90Kg

Cast aluminium  
removable,  
lifting weight:  
45kg

CAN500

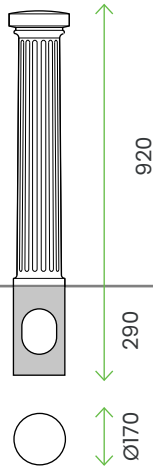

55Kg

Cast aluminium  
removable,  
lifting weight:  
25kg

DOR520

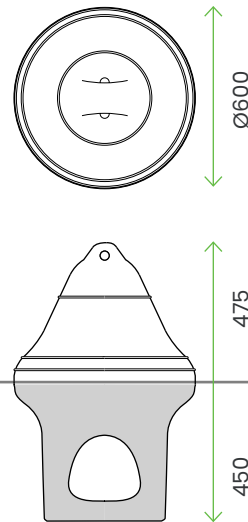

165Kg

Cast iron  
traffic bollard

BELL 100

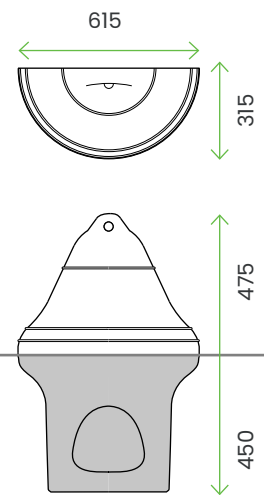

80Kg

Cast iron  
traffic bollard

BELL120

**Weight**

**Options**

**Code**

## CAST IRON BOLLARDS

### Hammersmith



### Manchester (Round Base)



### City



### Capital



<b>Weight</b>	38Kg	52Kg	100Kg	35Kg
<b>Options</b>	Cast aluminium removable, lifting weight: 20kg	Cast aluminium removable, lifting weight: 25kg	Cast aluminium removable, lifting weight: 30kg	Cast iron removable, lifting weight: 35kg
<b>Code</b>	HAM500	MAN536RB	CIT538	CAP100

# Extras.

## Painting and highlighting

- Paint to a standard RAL colour
- Highlighting to enhance decorative features
- Reflective tape to improve the visibility of a bollard

## Removable bollards

For sites where temporary access is required, selected cast iron bollards can be adapted with a choice of 2 socket types, to allow for removal.

- Standard socket
- F1 socket

# Installation.

It is important that bollards have a suitable foundation so that they remain firmly in place if they are knocked at any time. Shown below are the minimum recommended requirements for concrete foundation blocks for fixed and removable bollards in typical installations in normal ground conditions.

## Particular attention should be paid to the following:

- Set the bollard at the depth / height as shown in the specific bollard illustration
- Ensure concrete penetrates through the below-ground apertures (where applicable) into the internal void of the bollard up to ground level

### Fixed bollard

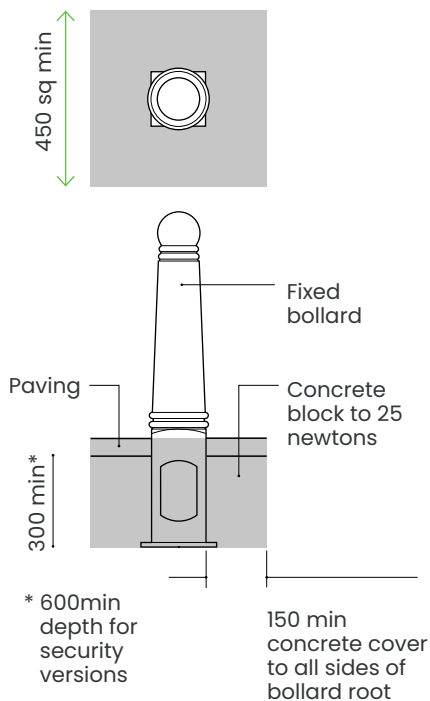

The professional advice of a highway / civil engineer should be sought if there are any queries regarding the ground conditions or doubts over the suitability of the foundation.

### Removable bollard: standard socket

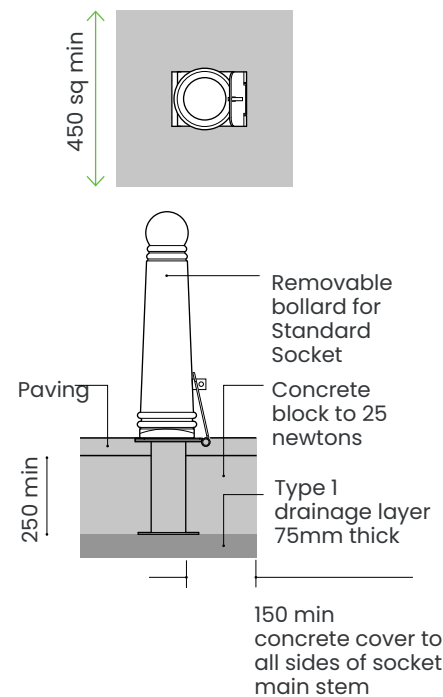

Ensure hinge plate is flush to ground level in closed position

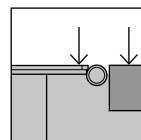

### Removable bollard: F1 series socket

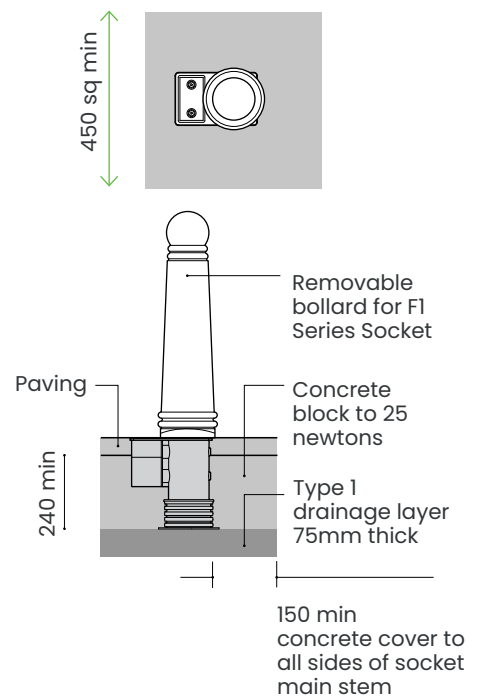

Ensure socket edge is flush to ground level

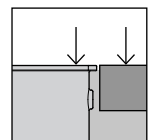

# Steel & Stainless Steel Bollards.

## Durable, simple yet sleek

Our range of steel and stainless steel bollards is based around standard circular tubular sections, with varying degrees of embellishment – from plain domed versions, to sloped tops.

Steel is not only **super easy to maintain** and **recyclable** it also offers improved tensile strength compared with cast iron.

Steel bollards are light in weight but tough and therefore suited to busy trafficked areas such as; public spaces, car parks and residential areas.

## STANDARD ZENITH BOLLARD OPTIONS

### Plain



Circular bollard with shallow domed top available in stainless steel, satin finish.

### Sloped top



Circular bollard with elliptical top plate sloped at 45 degree angle, available in stainless steel, satin finish.

		Standard Version		Security Version		Standard Version		Security Version	
A/g	900mm	1000mm	900mm	1000mm	900mm	1000mm	900mm	1000mm	
	B/g	300mm	300mm	600mm	600mm	300mm	300mm	600mm	600mm
Ø102mm	ZEN700	ZEN800	n/a	n/a	ZEN450	ZEN850	n/a	n/a	
	ZEN701	ZEN801	ZEN701SC	ZEN801SC	ZEN451	ZEN851	ZEN451SC	ZEN851SC	
Ø115mm	ZEN703	ZEN803	ZEN703SC	ZEN803SC	ZEN453	ZEN853	ZEN453SC	ZEN853SC	
	ZEN704	ZEN804	ZEN704SC	ZEN804SC	ZEN452	ZEN852	ZEN452SC	ZEN852SC	

## STAINLESS STEEL BOLLARDS

**Eltham**



**Millennium**

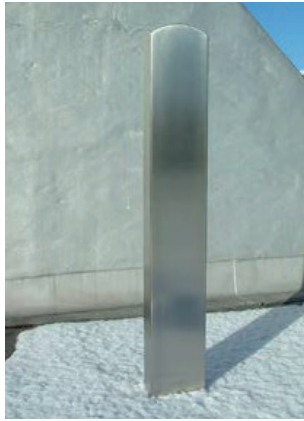

**Pinnacle**



**Transport**

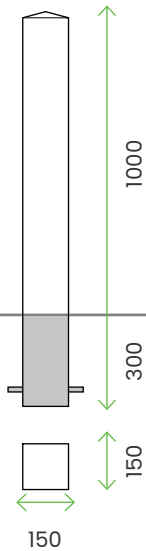

Removable bollard  
G316S/S

ELT715S  
G304 S/S  
satin polished

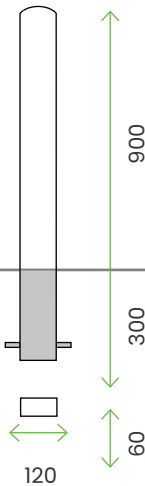

Removable bollard  
G316S/S

MIL701BS  
G304 S/S  
satin polished

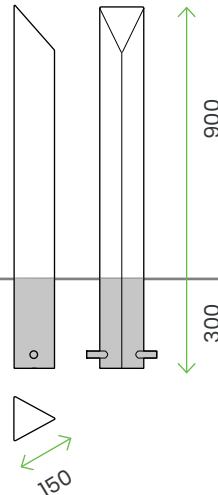

Removable bollard  
G316S/S

PIN452S  
G304 S/S  
satin polished

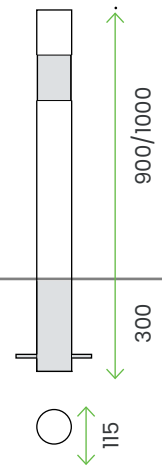

Grade 316 stainless steel, Mild steel galvanised, self-colour or with painted / coated finish, Reflective tape in red, white, yellow, blue, orange and green, Removable bollard

**TRL 700**  
900mm high, S/S  
G304, satin polished  
finish with black  
reflective tape band

**TRL 800**  
1000mm high, S/S  
G304, satin polished  
finish with black re-  
flective tape band

**Options**

**Code**

## TELESCOPIC BOLLARDS

### Driveway

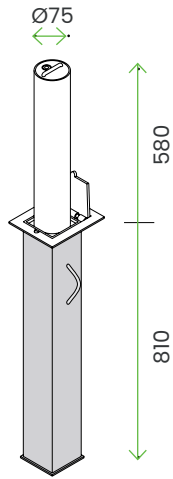

#### TPR 576

Standard specification, galvanised steel & polyester powder coated finish black or yellow

OPTIONS:  
Other BS / RAL colours

LIFTING WEIGHT:  
7Kg

### Round

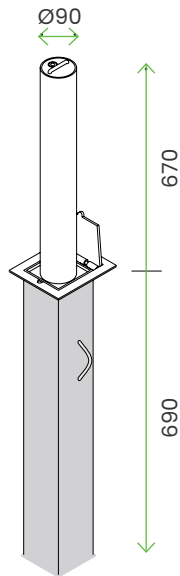

#### TPR 700

Standard specification, galvanised steel

LIFTING WEIGHT: 12Kg

#### TPR 800

Anti-ram raid specification, galvanised steel

LIFTING WEIGHT: 14Kg

#### TPR 390

Anti-ram raid specification, stainless steel in satin finish

LIFTING WEIGHT: 13Kg

### Lrg round

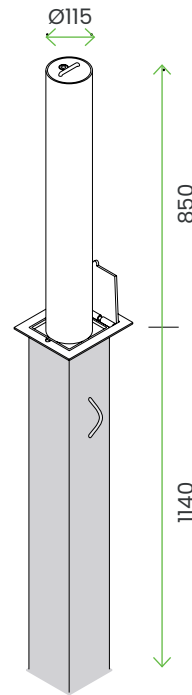

#### TPR 600

Standard specification, galvanised steel

LIFTING WEIGHT: 17Kg

OPTIONS:  
Polyester powder coated

#### TPR 300

Standard specification, stainless steel in satin finish

LIFTING WEIGHT: 13Kg

### Square

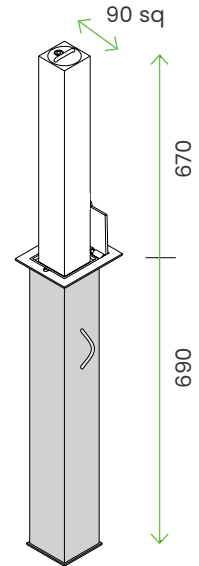

#### TPR 700

Standard specification, galvanised steel

LIFTING WEIGHT: 13Kg

OPTIONS:  
Polyester powder coated

#### TPR 800

Anti-ram raid specification, galvanised steel

LIFTING WEIGHT: 15Kg

OPTIONS:  
Polyester powder coated

# Extras.

## Reflective Tape

- Reflective tape to improve the visibility of a bollard
- Security version (on selected models)

## Materials & Finishes

- Stainless steel – G304 satin polished
- Stainless steel – G316 satin polished

# Installation.

It is important that bollards have a suitable foundation so that they remain firmly in place if they are knocked at any time. Shown below are the minimum recommended requirements for concrete foundation blocks for fixed and removable bollards in typical installations in normal ground conditions.

## Particular attention should be paid to the following:

- Set the bollard at the depth / height as shown in the specific bollard illustration
- Ensure concrete penetrates through the below-ground apertures (where applicable) into the internal void of the bollard up to ground level

### Fixed bollard

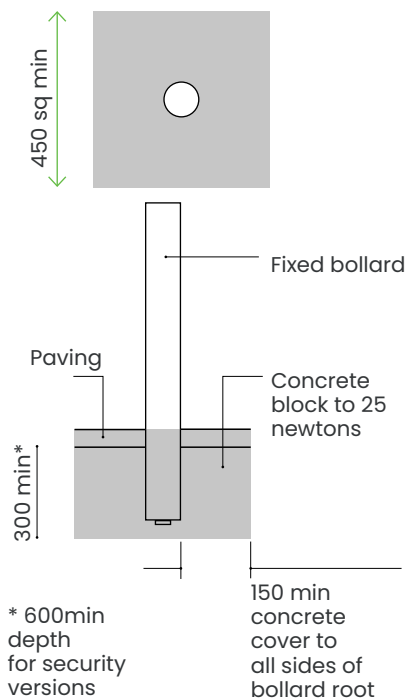

The professional advice of a highway / civil engineer should be sought if there are any queries regarding the ground conditions or doubts over the suitability of the foundation.

### Removable bollard: std socket

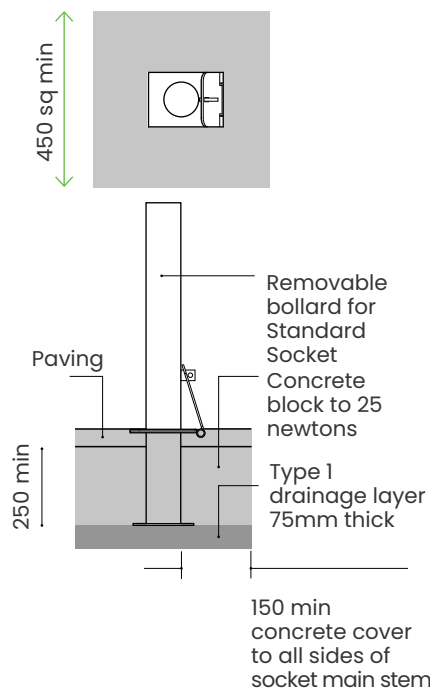

### Removable bollard: f1 series socket

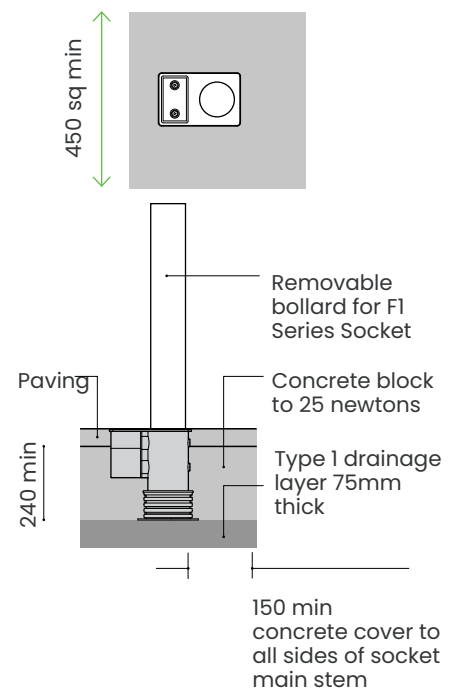

# Timber Bollards.

## Hard wearing, environmentally friendly

Furnitubes' timber bollards come in three styles - the finely detailed and premium quality **Ashdown** and **Epping** hardwood ranges, and the simple yet effective style of the **Garrick** bollard.

All ranges are offered in several standard sizes and four standard heights above ground between 500mm and 1000mm. We offer machined feature grooves (into which reflective tape can be applied for improved visibility) on all timber bollards.

# Ashdown.

## Premium circular bollards

Ashdown is a premium range of circular bollards with a high quality machined finish, including a domed top to aid water run-off. The range is particularly suited therefore to urban applications where pedestrians may come into close contact with the bollards, although they are also popular in roadside verge situations.

Opepe - classified as Very Durable hardwood with good fire resistance - is the standard material for the Ashdown range, finished with a coat of woodstain to provide a soft sheen finish and extend the rich colouration as the timber weathers over time.



Ø125-200

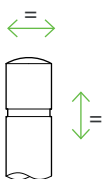
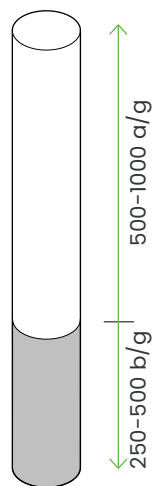

Standard  
grooved neck  
position

### Above Ground

500mm    600mm    800mm    1000mm

### Below Ground

250mm    300mm    400mm    500mm

<b>Ø125mm</b>	ARP125750	ARP125900	ARP1251200	ARP1251500
<b>Ø150mm</b>	ARP150750	ARP150900	ARP1501200	ARP1501500
<b>Ø175mm</b>	ARP175750	ARP175900	ARP1751200	ARP1751500
<b>Ø200mm</b>	ARP200750	ARP200900	ARP2001200	ARP2001500

### Standard specification

Opepe hardwood with Sadolin Woodstain finish, colour 'Mais'

Material is subject to availability - alternatives may be offered including Wallebe and Greenheart

Sizes stated are nominal; finished sizes may be reduced due to machining tolerances

### Options

- With grooves and optional reflective tape
- Pre-drilled to accept circular steel rails
- Pre-fitted eyebolts for chainlink connection
- Reflective plates, discs or D.f.T. sign plates (only bollards with grooves)
- Removable bollard with galvanised mild steel or stainless steel socket

Refer to table for standard section and above / below ground dimension combinations

# Epping.

## Premium square bollards

The Epping range are square bollards, with a four-way weathered top and soft chamfered vertical edges, are a popular choice for residential developments in particular.

Manufactured from Opepe hardwood as standard, the bollards offer long term durability and good fire resistance compared with many other timbers. Grooved neck features can be readily machined into the bollards, with the further option of the application of reflective tape to improve their visibility. Other standard options include pre-drilled holes for rails and pre-fitted eyebolts for the chainlink connection.

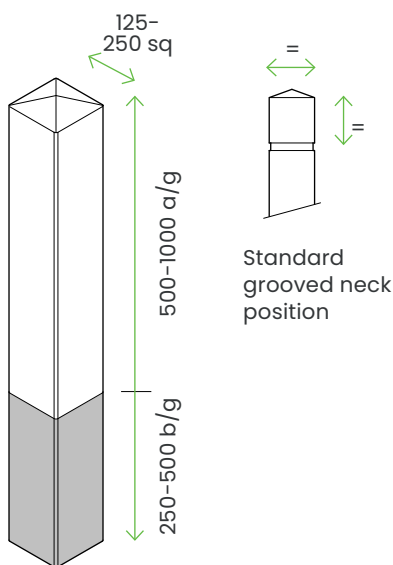

### Above Ground

500mm    600mm    800mm    1000mm

### Below Ground

250mm    300mm    400mm    500mm

<b>Ø125mm</b>	ESP125750	ESP125900	ESP1251200	ESP125/1500
<b>Ø150mm</b>	ESP150750	ESP150900	ESP1501200	ESP150/1500
<b>Ø175mm</b>	ESP175750	ESP175900	ESP1751200	ESP175/1500
<b>Ø200mm</b>	ESP200750	ESP200900	ESP2001200	ESP200/1500
<b>Ø225mm</b>	ESP225750	ESP225900	ESP2251200	ESP225/1500
<b>Ø250mm</b>	ESP250750	ESP250900	ESP2501200	ESP250/1500

### Standard specification

Opepe hardwood with Sadolin Woodstain finish, colour 'Mais'

Material is subject to availability – alternatives may be offered including Wallebe and Greenheart

Sizes stated are nominal; finished sizes may be reduced due to machining tolerances

### Options

- With grooves and optional reflective tape
- Pre-drilled to accept circular steel rails
- Pre-fitted eyebolts for chainlink connection
- Reflective plates, discs or D.f.T. sign plates
- Removable bollard with galvanised mild steel or stainless steel socket

Refer to table for standard section and above / below ground dimension combinations

# Garrick.

## Budget-range square bollards

Garrick square bollards are a basic range product in a choice of Green Oak or Pressure Treated Spruce / Whitewood in a planed finish with a four-way weathered top and chamfered edges.

As with all other timber bollards, the Garrick is offered in plain form, with grooves and the option of reflective tape.

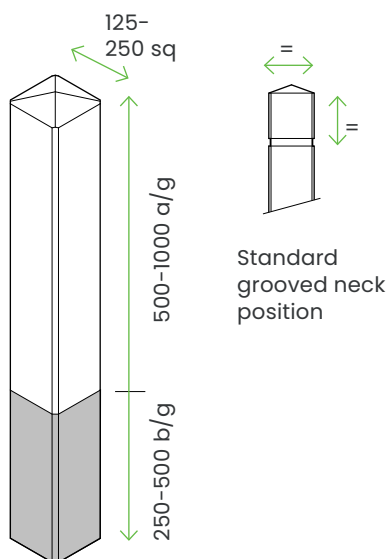

### Above Ground

500mm    600mm    800mm    1000mm

### Below Ground

250mm    300mm    400mm    500mm

<b>Ø125mm</b>	GAR125750	GAR125900	GAR1251200	GAR1251200
<b>Ø150mm</b>	GAR150750	GAR150900	GAR1501200	GAR1501200
<b>Ø175mm</b>	GAR175750	GAR175900	GAR1751200	GAR1751200
<b>Ø200mm</b>	GAR200750	GAR200900	GAR2001200	GAR2001200
<b>Ø225mm</b>	GAR225750	GAR225900	GAR2251200	GAR2251200
<b>Ø250mm</b>	GAR250750	GAR250900	GAR2501200	GAR2501200

### Standard specification

Green Oak or Pressure Treated Spruce / Whitewood (softwood)  
 Sizes stated are nominal; finished sizes may be reduced due to machining tolerance

Refer to table for standard section and above / below ground dimension combinations

### Options

- With grooves and optional reflective tape

# Extras.

## Grooves and Tape

- With grooves and optional reflective tape
- Reflective tape to improve the visibility of a bollard

\*Please note that the bollard is a loose fit in the socket and is not 100% rigid (but can't be removed if locked) and is not designed for vehicular overrun.

## Removable (Ashdown & Epping)

For sites where temporary access is required, selected timber bollards can be adapted to allow for removal.

Comprising a galvanised mild steel or stainless steel socket and a bollard fitted with a locking hasp, suitable for securing with an FB14 padlock (please order separately).

# Installation.

It is important that bollards have a suitable foundation so that they remain firmly in place if they are knocked at any time. Shown below are the minimum recommended requirements for concrete foundation block for bollards in a typical installation in normal ground conditions. Particular attention should be paid to setting the bollard at the specified depth below ground / height above ground.

For removable bollard sockets ensure the hinge plate is set flush to ground level in its closed position. The professional advice of a highway / civil engineer should be sought if there are any queries regarding the ground conditions or doubts over the suitability of the foundation.

## Fixed bollard

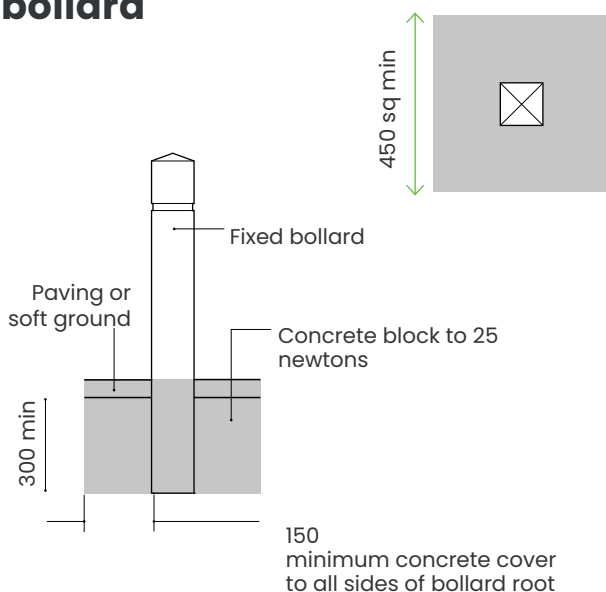

## Removable bollard

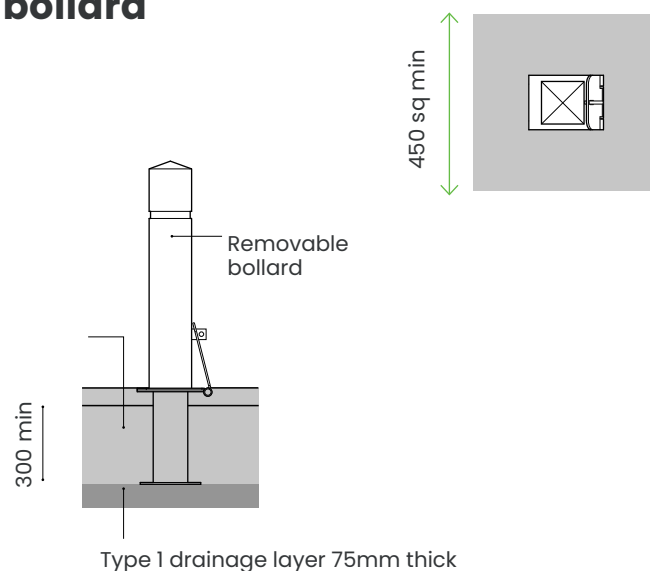

# Case studies.

Some of our recent projects where you can see **Zenith Bollard** in its full glory.



**Zenith Bollard**  
Epping Forest  
Shopping Park, Essex  
Client: McLaughlin  
& Harvey

# Why Furnitubes.

- **Made in the UK**  
our factory is based in Kent, so expect faster leadtimes and no supply chain delays
- **Easy to maintain + low labour costs**  
we make sure that fixing points are easily accessible so slats and brackets can be changed easily when damaged
- **Modular solutions**  
our ranges are modular and customisable, seating and planters can be easily combined, be creative without blowing the budget
- **Our approach**  
we take a considered approach to design, it's not just about the end product. We take everything in the process into consideration, we are collaborative and we are committed to producing products that improve our environment & keep people safe.



## Our Process.

- **Get in touch** – it's as simple as that, give us a call or drop us an email, we're happy to help whatever the medium!
- **Collaborate** – Depending on your needs, you might not actually need us at this stage, that's the beauty of our modular ranges – they're designed with you in mind, so you can specify with ease. Nevertheless, we are here for you if you do – our design team are always on hand to discuss the nitty gritty of your project.
- **Specification** – This is where our team of experts take the wheel and help you with sketches, CADs and more to help you specify our products as easily as possible.
- **Production + delivery** – all of our products are designed and manufactured in the UK allowing us to give you shorter lead times. With a dedicated project manager keeping you in the loop, you can trust everything is in hand.

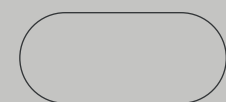
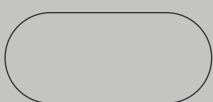
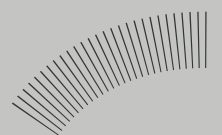
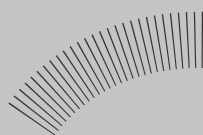
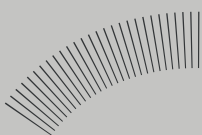
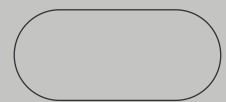
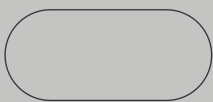
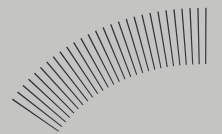
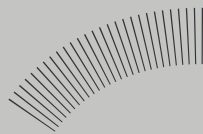
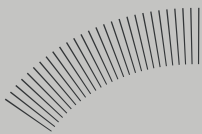
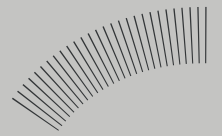
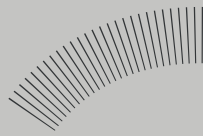
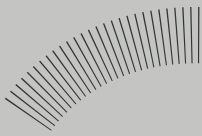
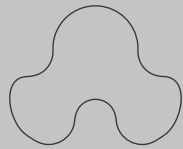



Furnitubes



Furnitubes



Furnitubes International UK

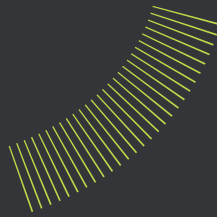

**furnitubes**  
shaping outdoor spaces

The Leather Market, Unit 9.1.1, Weston St, London SE1 3ER  
T: +44 (0)20 8378 3200  
sales@furnitubes.com www.furnitubes.com